



# HYDRAULIC WINCH 10JP



**Assembly & Operating Instructions**

---

## **CONTENTS**

<b>INTRODUCTION .....</b>	<b>1</b>
<b>SAFETY WARNINGS AND PRECAUTIONS.....</b>	<b>2</b>
<b>WINCH WARNINGS AND PRECAUTIONS .....</b>	<b>3</b>
<b>UNPACKING .....</b>	<b>4</b>
<b>INSTALLATION.....</b>	<b>4</b>
<b>OPERATION .....</b>	<b>8</b>
<b>WINCH ACCESSORIES YOU WILL NEED.....</b>	<b>9</b>
<b>RIGGING TECHNIQUES .....</b>	<b>9</b>
<b>LUBRICATION .....</b>	<b>10</b>
<b>CABLE ASSEMBLY REPLACEMENT.....</b>	<b>10</b>
<b>TROUBLE SHOOTING.....</b>	<b>11</b>
<b>WINCH ASSEMBLY DRAWING.....</b>	<b>12</b>
<b>WINCH PARTS LIST .....</b>	<b>13</b>
<b>SPECIFICATION (HWP20000U/A、U3/A3) .....</b>	<b>14</b>

## **INTRODUCTION**

Congratulations on your purchase of a highest class advanced powerful winch. We design and build winches to strict specifications and with proper use and maintenance should bring you years of satisfying service.

** WARNING - Read, study and follow all instructions before operating this device. Failure to heed these instructions may result in personal injury and/or property damage.**

Your winch can develop tremendous pulling forces and if used unsafely or improperly could result in property damage, serious injury or death. Throughout this manual you will find the following symbols for caution, warning and danger. Pay particular attention to the notes preceded by these symbols as they are written for your safety. Ultimately, safe operation of this device rests with you, the operator.





This indicates a potentially hazardous situation which, if not avoided, may result in minor or moderate injury. This notation is also used to alert you against unsafe practices.





This indicates a potentially hazardous situation which, if not avoided, could result in death or serious injury.

## **SAFETY WARNINGS AND PRECAUTIONS**

 **WARNING:** When using the tool, basic safety precautions should always be followed to reduce the risk of personal injury and damage to the equipment. Read all this instructions before using this tool!

 **WARNING – Keep children away.** Children must never be allowed in the work area Do not let them handle machines, tools, or extension cords.

 **WARNING – Store idle equipment.** When not in use, tools must be stored in a dry location to inhibit rust. Always lock up tools and keep out of reach of children.

 **WARNING – Dress properly.** Do not wear loose clothing or jewelry as they can be caught in moving parts. Protective, electrically non-conductive clothes and non-skid footwear are recommended when working. Wear restrictive hair covering to contain long hair.

 **WARNING – Use eye and ear protection.** Always wear impact safety goggles. Wear a full face shield if you are producing metal filings or wood chips. Wear a dust mask or respirator when working around metal, wood, and chemical dusts and mists.

 **WARNING – Maintain tools with care.** Keep tools sharp and clean for better and safer performance. Follow instructions for lubricating and changing accessories. Inspect tool cords periodically and, if damaged, have them repaired by an authorized technician. The handles must be kept clean, dry, and free from oil and grease at all times.

 **WARNING – Disconnect switch.** Unplug switch when not in use.

 **WARNING – Stay alert.** Watch what you are doing, use common sense. Do not operate any tool when you are tired.

 **WARNING – Check for damaged parts.** Before using any tool, any part that appears damaged should be carefully checked to determine that it will operate properly and perform its intended function. Check for alignment and binding of moving parts; any broken parts or mounting fixtures; and any other condition that may affect proper operation. Any part that is damaged should be properly repaired or replaced by a qualified technician. Do not use the tool if any switch does not turn “On” and “Off” properly.

 **WARNING – Replacement parts and accessories.** When servicing, use only identical replacement parts. Use of any other parts will void the warranty. Only use accessories intended for use this tool.

 **WARNING – Do not operate tool if under the influence of alcohol or drugs.** Read warning labels on prescription to determine if your judgment or reflexes are impaired while taking drugs. If there is any doubt, do not operate the tool.

## **WINCH WARNINGS AND PRECAUTIONS**

 **WARNING** – Keep hands and body away from Fairlead (cable intake slot) when operating.

 **WARNING** – Secure vehicle in position before using winch.

 **WARNING** – Be certain winch is properly bolted to a structure (or vehicle) that can hold the winch load.

 **WARNING** – Do not use inappropriate attachments to extend the length of the winch cable.

 **WARNING** – Never lift people or hoist loads over people.

 **WARNING** – Never come in between the winch and the load when operating.

 **WARNING** – Do not apply load to winch when cable is fully extended. Keep at least 5 full turns of cable on the spool.

 **WARNING** – After moving an item with the winch, secure the item. Do not rely on the winch to hold it for an extended period.

 **WARNING** – Examine winch before using. Components may be affected by exposure to chemicals, salts, and rust.

 **WARNING** – Never operate winch if cable shows any signs of weakening, such as knotting or kinking.

 **WARNING** – Do not cross over or under cable when the winch is under load.

 **WARNING** – Do not move your vehicle with the cable extended and attached to the load. You could easily exceed the winch rating and snap the cable.

 **WARNING** – Use gloves while handling cable.

 **WARNING** – When the vehicle is parked on an incline you should use wheel chocks.

 **WARNING** – Re-spool cable properly avoiding cable misalignment.

 **WARNING** – The winch cable must be wound onto the drum under a load of at least 10% of the rated line pull or the outer wraps will draw into inner wraps and damage winch cable

 **WARNING** – Before operating the winch under load you should check proper function of the winch by engaging and disengaging the clutch, by operating the directional controls, and operating the speed controls. This will ensure that the winch is working properly and will help prevent unintended damage and injury. Cycling the winch prior to loading will also ensure the gears are properly aligned.

## **UNPACKING**

When unpacking, check to make sure all parts are included. Refer to Assembly Drawings and Parts List (both with the like item numbers) at the end of this manual.

## **INSTALLATION**

1. Your 20000lb winch is designed with a bolt pattern that is standard in this class of winch. Many winch mounting kits are available that utilize this bolt pattern for the most popular vehicle and mounting channels. If you cannot find a kit locally, contact us and we will provide you with the name of a dealer near you. If you will utilize the mounting channel you must ensure that it is mounted on a flat surface so that the three major sections (motor, drum and gear housing) are properly aligned. Proper alignment of the winch will allow even distribution of the full rated load.
2. Start by connecting the roller fairlead to the mounting channel using 2 each of the cap screw, flat washer, lock washer and securing with nut. (Make sure the screw is placed through the mounting channel and roller fairlead from inside the channel. This will allow enough clearance for the winch to be placed in the channel without obstruction.)

3. Mount winch to the vehicle using high strength cap screw. It should be aligned and secured to a solid part of the vehicle (front or rear) where the the full rated load will be evenly distributed.
4. Connect the two-color (positive) battery cable from the directional valve to screw-down positive (+) terminal to the 12/24 volt battery.
5. Please refer to installation illustration.

### **Mounting The Balance Valve:**

The balance valve supplied is simply connected to motor. Be sure the balance valve's installing direction meets hydraulic principle chart. Otherwise, the winch will not reach the rated line pull, and it is also dangerous for winch to power off the cable with heavy load. If this symptom happens, simply disconnect the balance valve: exchange the oil hole between hydraulic motor and balance valve, while your winch is working in different direction ,change A→C1,B→C2 into A→C2,B→C1.And reconnect it. If your order demand the balance valve should be supplied, it will have been connected with the motor at the factory.

### **Plumbing Connections:**

Keep all hoses away from any areas where heat may be considered too extreme such as an exhaust manifold or turbo. Lines should not be allowed to rub on any abrasive or vibrating surfaces. In some applications, 90°fittings on the directional valve and motor or balance valve are necessary to make hose mounting more flexible. After plumbing has been laid out on vehicle, install o-ring fittings supplied to valve. Torque tight. Do not over tighten any fittings. Install o-ring fittings on Winch Motor. Torque tight. Connect any hose port A on motor or port V1 on balance valve to port A on directional valve, port B on motor or port V2 on balance valve to port B on directional valve, port P on directional valve to pump's high pressure port, port T on valve to reservoir, if necessary Connect any hose port S on valve to steering box. Attach any o-ring or seal from vehicles original tube fitting to tube fitting.

### **Working hydraulic principle chart and installation illustration:**

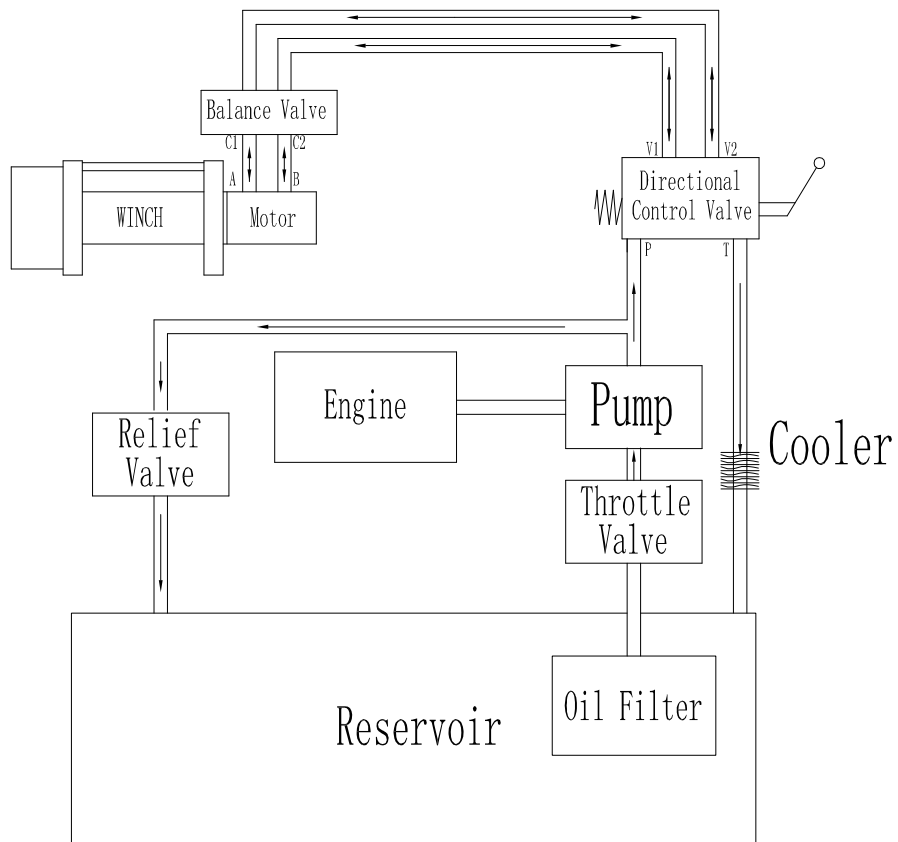
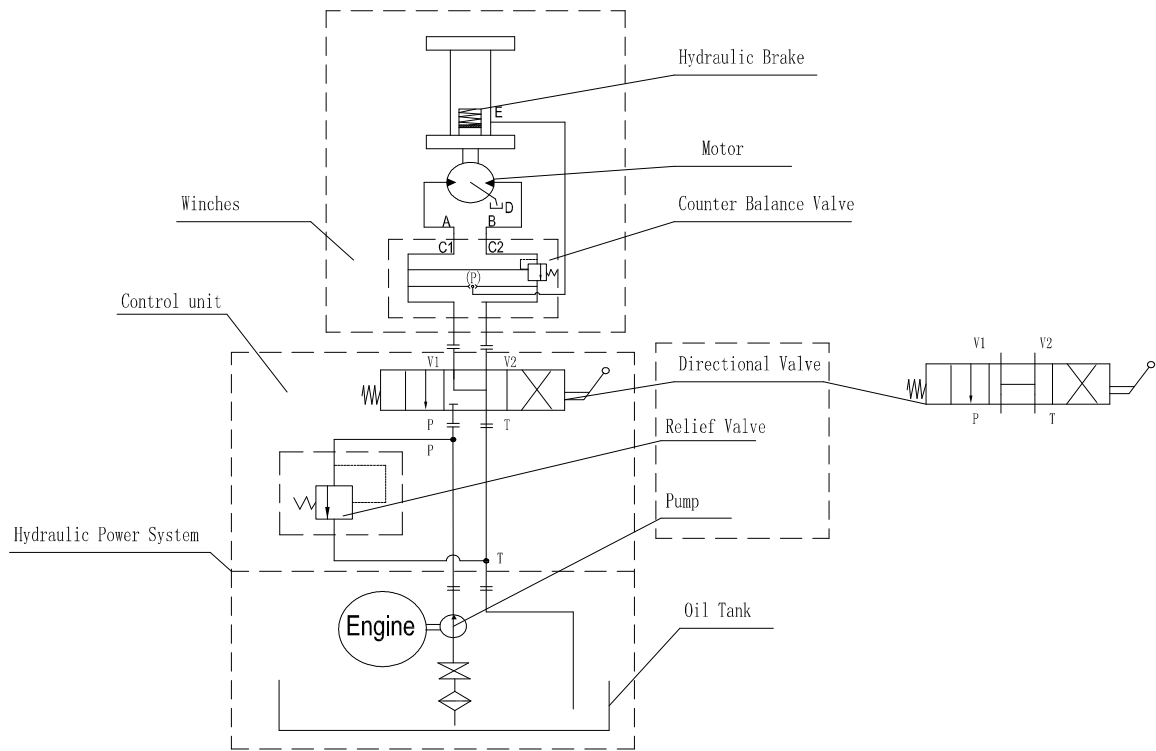

**Air actions clutch**



- Air clutch for Free spool

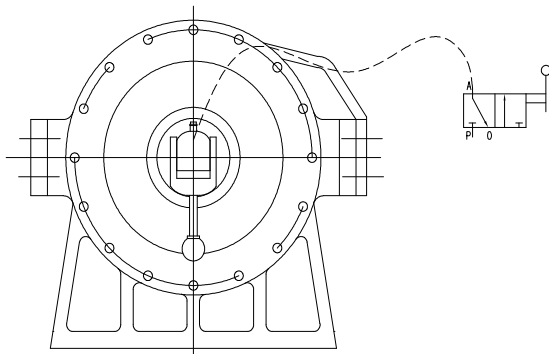

- Air clutch for free spool and two speed

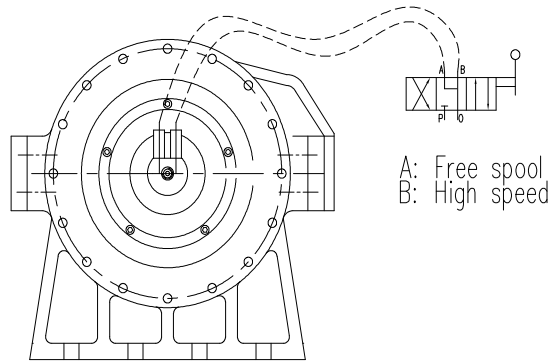

A: Free spool  
B: High speed

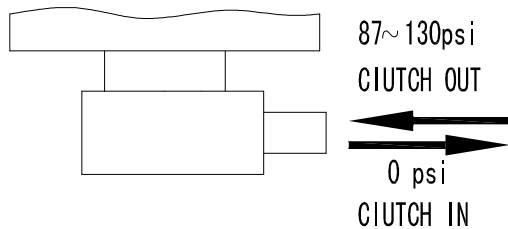

**⚠ WARNING**

1. Clutch in all the time, when clutch out, need pressure 87~130psi into winch.
2. Pressure should not below 87psi.
3. When winch is loaded and working, Do not clutch out.

**⚠ Caution:**

The hydraulic system needs a relief valve to ensure the system safety. The absence of such a valve could cause serious injury and damage the winch.

Winch battery cables should be placed so that there is a small amount of slack in the cable.

If you are using a heat exchanger with your application to cool the hydraulic fluid you should refer to the illustration about mounting.

You should check the hydraulic fluid level and replace any that may have seeped out. The hydraulic system should be purged at this time. Listed below are the directions on how to purge the hydraulic system.

- 1) Start the engine.
- 2) Power the winch to draw out about 5 feet of cable.
- 3) Shut down the engine.
- 4) Check the fluid level and fill as needed.
- 5) Repeat steps 1 through 4 as necessary.
- 6) Start the engine.
- 7) Move the cable into the desired position.
- 8) Turn the wheels on the vehicle from the right lock to the left lock positions five times to help bleed the hydraulic system.

9) If the hand control unit is working backwards, simply exchange the brown and the white wire connections within the valve.  
Test the winch for proper operation. Refer to the section below.

## **OPERATION**

### **⚠ WARNING**

- 1 Make sure clutch is totally engaged before starting any winch operation;**
- 2 Stay clear and away from raised loads;**
- 3 Stay clear of cable while pulling do not try to guide cable;**
- 4 A min. of 5 wraps of cable around the drum barrel.**

### **General information:**

The Winch's standard equipments contain gear reducer, drum, hydraulic motor, solenoid valve, switch assembly, female connector and plumbing fittings. The winch obtains its pressure from the vehicle's existing power steering pump or other hydraulic power. The winch is totally sealed, can be used underwater.

There are several other ways to supply power to the winch. The first way is to use an individual pump for engineering use. The second way is to provide the winch's hydraulic pressure with the vehicle's existing power steering pump (See Installation Instructions).

① Use a suitable individual pump, which doesn't have an oil pressure relief valve. It will supply pressure for both the steering box and the winch.

② Use a combined pump with an integrated oil valve. The oil valve will supply two kinds of flow based on the difference in demand. One type of flow will be constant and should be used with the steering system. The other will provide higher pressure and is for engineering use.

### **⚠ Caution:**

Hydraulic system needs a relief valve to make sure the system is safe; if there is no relief valve in the system; it would be a serious danger and the system can't operate. If your winch is driven by an existing hydraulic power system, the relief valve is also existing.

## Winch working demonstration:

1. Disengage the clutch by turning the clutch to the “Free Spool” position.
2. Grab the cable assembly and pull the cable to the desired length, then attach to item being pulled.

**Caution:** Always leave at least five turns of cable on the drum; Review Winch Safety Warnings and Precautions on page 2, 3 before continuing.

3. Reengage the clutch by turning the clutch assembly to the “High Speed” or “Low Speed” position as needed.
4. Insert the switch assembly connector onto the directional valve
5. Test-run winch in both directions. Turn the winch in each direction for about one or two seconds meantime make the clutch totally engaged automatically.
6. While standing aside of the tow path, hold and operate the switch assembly supplied by your choice. Wait until the motor stops before reversing directions.
7. When the towing is finished, remove the switch assembly from the female connector of the directional valve and replace the female connector cover.

## WINCH ACCESSORIES YOU WILL NEED

### *NOT INCLUDED WITH YOUR WINCH*

Gloves – For handling the wire rope and hook strap.

Anchor Strap/Chain – Tree saver anchor straps are made of high quality nylon with high tensile strengths up to 15000lbs.

Heavy Blanket – place on the cable to absorb energy should the wire rope break.

## RIGGING TECHNIQUES

### Self-Recovery

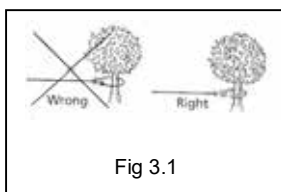
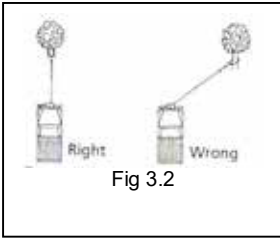

Fig 3.1

Locate a suitable anchor such as a strong tree trunk or boulder.

Always use a sling as an anchor point. **⚠ CAUTION** Do not attach the clevis hook back onto the cable as this could cause damage to the cable. As shown in Fig 3.1



**⚠ CAUTION** Do not winch from an acute angle as the wire rope will pile up on one side of the drum causing damage to wire rope and the winch. Fig 3.2

Short pulls from an angle can be used to straighten the vehicle. Long pulls should be done with the wire rope at a 90° angle to the winch/vehicle.

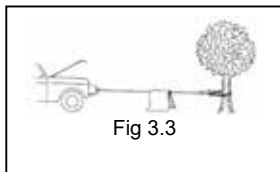

When pulling a heavy load, place a blanket or jacket over the wire rope five or six feet from the hook. In the event of a broken cable it will dampen the snap back. For additional protection open the hood of the vehicle as shown in Fig 3.3

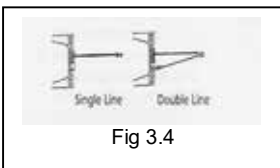

For pulls over 70% rated line pull, we recommend the use of the snatch block/pulley block to double line the wire rope. Fig 3.4

This reduces the load on the winch and the strain on the rope by up to 50% depending on the included angle.

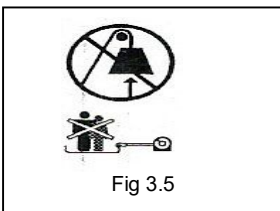

**WARNING** - Never use your winch for overhead hoisting or for lifting people or moving people.

## **LUBRICATION**

1. All moving parts within the Winch having been Lubricated using high temperature lithium grease at the factory. No internal lubrication is required.
2. Lubricate Cable Assembly periodically using a light penetrating oil.

## **CABLE ASSEMBLY REPLACEMENT**

If the wire rope has become worn or is beginning to show signs of strands breaking, it must be replaced before being used again.

1. Turning clutch to the “Free Spool” position.

2. Extend cable assembly to its full length. Note how the existing cable is connected to the drum.
3. Remove old cable assembly and attach new one as the old cable connected to the drum. Insert the end of the new rope and secure the screw being tightly screwed
4. Turning clutch to the “High Speed” position.
5. Retract cable assembly onto drum, first five wraps being careful not to allow kinking, then winch cable must be wound onto the drum under a load of at least 10% rated line pull.

**⚠ WARNING** - Only replace the wire rope with the identical replacement part recommended by the manufacturer.

### **TROUBLE SHOOTING**

<b>SYMPTOM</b>	<b>POSSIBLE CAUSE</b>	<b>SUGGESTED ACTION</b>
Winch does not turn .	-Insufficiently hydraulic system pressure. -Improper connections of hydraulic system, no oil into motor.	-Check relief valve regulate pressure. -Check all the plumbing fixtures according to the working principle chart. -Defective directional control valve.
Motor runs but Cable drum does not turn	- The clutch is Not engaged	-Turn the clutch to the high or lows peed position. If problem still persists, a qualified technician needed to check and repair.
Winch drum runs slowly or without normal power.	-Insufficient pressure or oil flow -Insufficient fluid in the system - Wrong winch working direction.	-Bump is not suitable or defective. Change a new one or a suitable one -Check fluid level. Add fluid until full. -Change the connection of balance valve and motor.
Winch brake not working normally.	-Hydraulic pressure remnants in brake while winch stop. -Wrong winch working direction.	-Use bigger back oil pipe. -Change the connection of balance valve and motor.
Winch cannot spool off wire rope with load smoothly.	-Wrong winch working direction.	-Change the connection of balance valve and motor.

# WINCH ASSEMBLY DRAWING

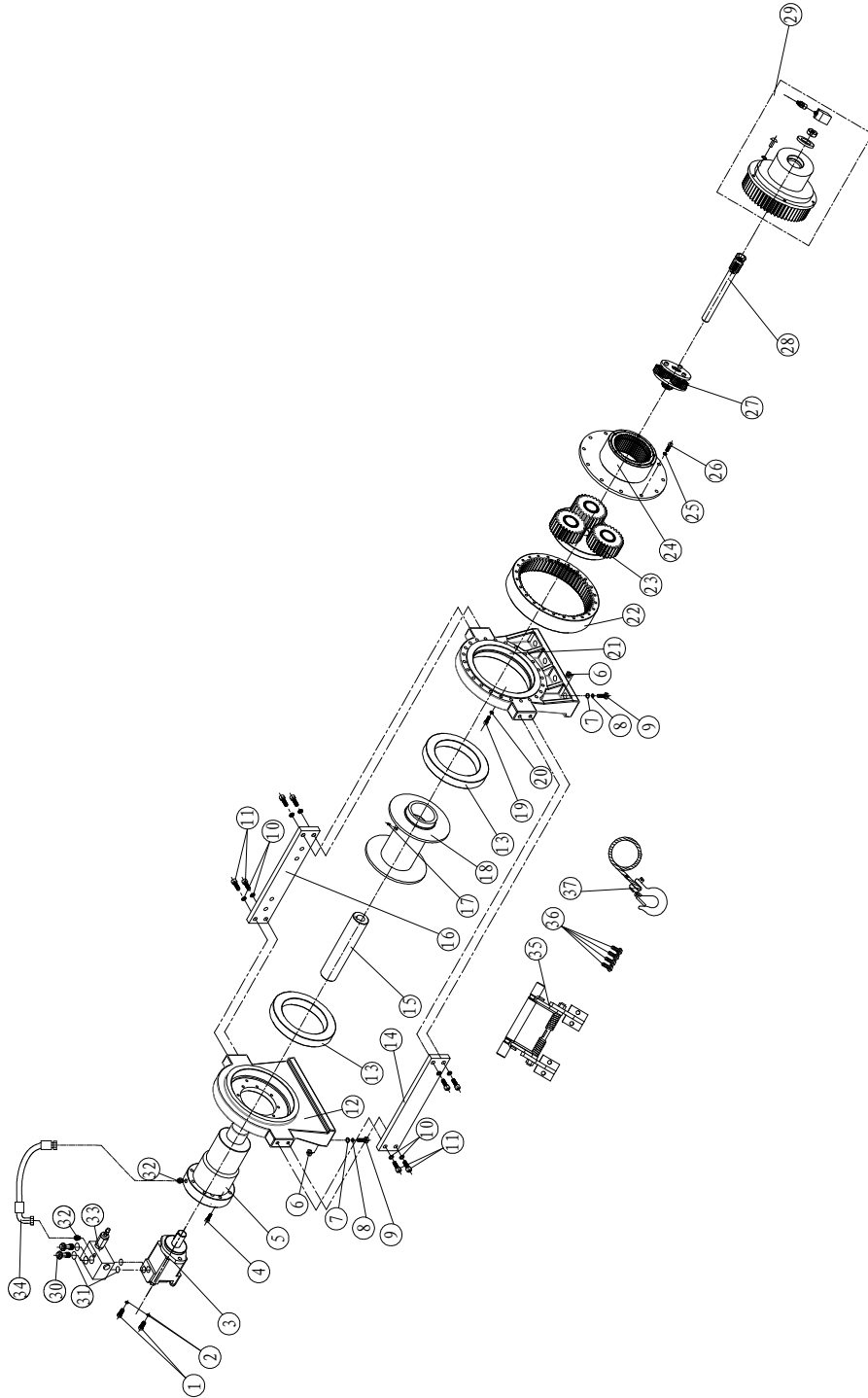

## WINCH PARTS LIST

No.	Part #	Qty	Description	Remark
1	C200NH0001	2	Screw M12 x 35	
2	C200NH0002	2	Lock Washer $\Phi$ 12	
3	C200NH010	1	Hydraulic Motor	
4	C200NH0003	8	Screw M8 x 30	
5	C200NH0200	1	Break / Shaft Assembly	
6	C200NH0004	8	Hex Flange Nut M14	
7	C200NH0005	8	Thin Flat Washer $\Phi$ 14	
8	C200NH0006	8	Lock Washer $\Phi$ 14	
9	C200NH0007	8	Cap Screw M14 x 50	
10	C200NH0008	4	Lock Washer $\Phi$ 10	
11	C200NH0009	4	Screw M10 x 30	
12	C200NH0010	1	Front Bearing	
13	C200NH0011	2	Roller Bearing	
14	C200NH0012	1	Frontal Mounting Plate	
15	C200NH0013	1	Coupling	
16	C200NH0014	1	Back Mounting Plate	
17	C200NH0015	1	Screw M8 x 10	
18	C200NH0300	1	Drum Assembly	
19	C200NH0016	24	Screw M8 x 35	
20	C200NH0017	24	Lock Washer $\Phi$ 8	
21	C200NH0018	1	End Bearing	
22	C200NH0019	1	Gear-Ring	
23	C200NH0400	1	Gear Carrier Assembly (Output)	
24	C200NH0500	1	Cam Gear (Input)	
25	C200NH0017	12	Lock Washer $\Phi$ 8	
26	C200NH0020	12	Screw M8 x 20	
27	C200NH0600	1	Gear Carrier Assembly (Input)	
28	C200NH0021	1	Transmission Shaft	
29	C200NH0700	1	Clutch Assembly	
30	C200NH0022	2	Screw	
31	C200NH023	4	Seal Ring	
32	C200NH0800	2	Tube Fittings Assembly	
33	C200NH0900	1	Balanced Valve Assembly	
34	C200NH1000	1	Plumbing Fixtures	
35	C200NH1100	1	Tensioned Of Steel Wire Supplied Assembly	
36	C200NH0024	4	Screw M10 x 25	
37	C200NH1200	1	Cable Assembly	

## SPECIFICATION

Rated line pull	20000 lbs (9072 kgs)
Motor displacement	100ml/r
Oil flow	15~75L/min
Pressure	17.5Mpa
Gear reduction ratio	39:1
Cable (Dia. × L)	Ø0.59" × 157 ' (Ø15mm × 48m)
Drum size(Dia. × L)	Ø5.4 " × 12.4" (Ø138mm × 316mm)
Mounting bolt pattern	17.0 " × 2.5 " × 7.6 " (431mm × 64mm × 192mm) 8-M14
Overall dimensions (L × W × H)	32.7" × 15.4" × 12.6" 830mm × 390mm × 320mm
Net weight lbs(kg)	360 163

### Pull , Speed, Pressure, Flow (First layer)

Line pull lbs (kgs)	Pressure Mpa(Psi)	Flow G/min (L/min)	Line speed ft/min(m/min)
0	2.5(362.6)	4.0(15)	5.9(1.8)
4000(1814)	4.2(609.1)	7.9(30)	11.8(3.6)
8000(3629)	8.5(1232.8)	13.2(50)	19.7(6.0)
15000(6804)	14.0(2030.5)	15.9(60)	23.6(7.2)
20000(9072)	17.5(2538.1)	19.9(75)	29.5(9.0)

### Line pull, cable capacity and the line speed per layer

Layer of wire rope	Rated line pull lbs(kgs)	Total rope on drum ft (m)
1	20000(9072)	33.8(10.3)
2	16889(7661)	73.8(22.5)
3	14615(6630)	117.8(35.9)
4	12881(5843)	157.5(48.0)